

Flexibar Manual Tools

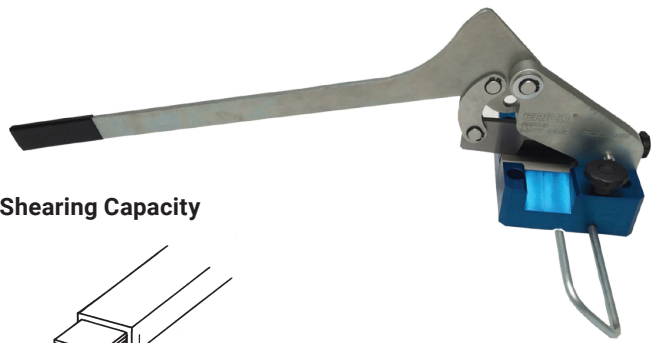

Shearing Capacity

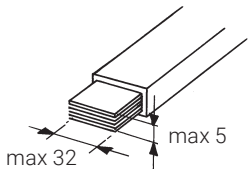

Flexibar 5 x 32 x 1 maximum

WARNING: Cutting solid bars will damage the tool

SHEARING TOOL

- Cuts quickly and accurately without burrs or deformation
- Cuts with the insulation on – without any damage
- Graduated endstop
- Cost-effective
- Spare blade MFCB



Article N°	Description		
559146	MFSHT-2 Flexibar Manual Shearing Tool	1	6 kg
559147	Replacement Blades for MFSH	1	0.5 kg



BENDING TOOL

- Bends quickly without insulation damage
- Manual saw guide included
- Adjustable angle up to 120°
- Bending radius: 5 mm
- Maximum capacity: Flexibar 10 x 100 x 1

Overall dimensions: L 170 x I 150 x H 220 mm

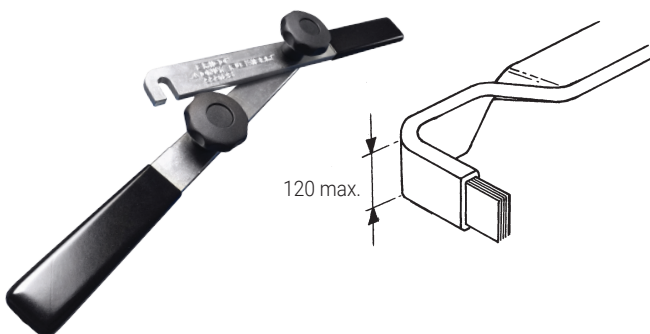

Article N°	Description		
559145	MFBT-2 Flexibar Manual Bending Tool	1	7 kg



TWISTING TOOL

- Unlimited possibilities of twisting or changing plane. Designed to be used with the bending tool

Overall dimensions: L 560 x I 150 x H 70 mm

Article N°	Description		
559148	MFTT-2 Flexibar Manual Twisting Tool	1	2.5 kg